

# F/L Series

## DIN W72×H72, W144×H72mm of 8 digit Up/Down counter

### ■ Features

- 8 digits counter: Selectable Up, Down, Up/Down mode
- Counting speed : 1cps, 30cps, 2kcps, 5kcps
- Selectable voltage input(PNP) or no-voltage input(NPN)
- Decimal point setting(Fixed decimal point of display)
- Wide range of power supply : 100-240VAC 50/60Hz  
12-24VAC/DC(Option)
- Built-in Microprocessor



**⚠ Please read "Caution for your safety" in operation manual before using.**

### ■ Ordering information

<b>F</b>	<b>8</b>	<b>A</b>	
		Output	A Single preset B Indicator
		Digit	8 99999999(8digit)
		Size	F DIN W72×H72mm L DIN W144×H72mm

### ■ Specifications

Model	Single preset	<b>F8A</b>	<b>L8A</b>
	Totalizer(Indicator)	<b>F8B</b>	<b>L8B</b>
Digit	8digit		
Digit size	W4×H8mm		W6.3×H10mm
Power supply	100-240VAC 50/60Hz, 12-24VAC/DC(Option)		
Allowable voltage range	90 to 110% of rated voltage		
Power consumption	AC Voltage type	• Indicator : Approx. 5.4VA • Single preset : Approx. 6.1VA(240VAC 50/60Hz)	
	AC/DC Voltage type	• Indicator : Approx. 5.5VA • Single preset : Approx. 6.3VA(240VAC 50/60Hz) • Indicator : Approx. 2.6W • Single preset : Approx. 3.1W(24VDC)	
Max. counting speed	Selectable 1cps/30cps/2kcps/5kcps by internal DIP switch		
Min. signal width	RESET input	Approx. 20ms	
Input type	CP1, CP2 Input	[Voltage input] Input impedance : 5.4kΩ, "H" level voltage : 5-30VDC, "L" level voltage : 0-2VDC	
	RESET input	[No-Voltage input] Impedance at short-circuit : Max. 1kΩ, Residual voltage at short-circuit : Max. 2VDC, Impedance at open-circuit : Min. 100kΩ	
One-shot output time	0.05 to 5sec		
Control output	Contact	Type	Single preset : SPDT(1c)
		Capacity	250VAC 3A resistive load
	Solid-state	Type	Single preset type : 1 NPN open collector
Capacity		30VDC Max. 100mA Max.	
Memory protection	Approx. 10 years(When using non-volatile semiconductor memory)		
External power	12VDC±10% 50mA Max.		
Insulation resistance	100MΩ(at 500VDC megger)		
Noise strength	AC power	±2kV the square wave noise(pulse width : 1μs) by the noise simulator	
	DC power	±500V the square wave noise(pulse width : 1μs) by the noise simulator	
Vibration	Mechanical	0.75mm amplitude at frequency of 10 to 55Hz(for 1 min.) in each of X, Y, Z directions for 1 hour	
	Malfunction	0.5mm amplitude at frequency of 10 to 55Hz(for 1 min.) in each of X, Y, Z directions for 10 minutes	
Shock	Mechanical	300m/s <sup>2</sup> (approx. 30G) in each of X, Y, Z directions for 3 times	
	Malfunction	100m/s <sup>2</sup> (approx. 10G) in each of X, Y, Z directions for 3 times	
Relay life cycle	Mechanical	Min. 10,000,000 operations	
	Electrical	Min. 100,000 operations(250VAC 3A at resistive load)	
Environment	Ambient temperature	-10 to 55°C, storage: -25 to 65°C	
	Ambient humidity	35 to 85%RH, storage: 35 to 85%RH	
Unit weight	F8A : Approx. 287g, F8B : Approx. 253g		L8A : Approx. 500g, L8B : Approx. 446g

※Environment resistance is rated at no freezing or condensation.

# 8 digit Up/Down/Up-Down Counter

## Dimensions

### F Series

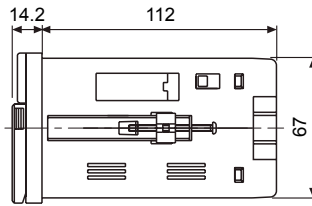
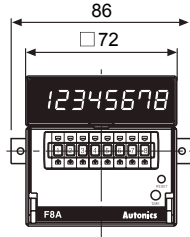

### Panel cut-out

(unit: mm)

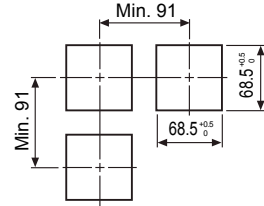

### L Series

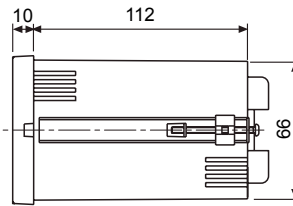
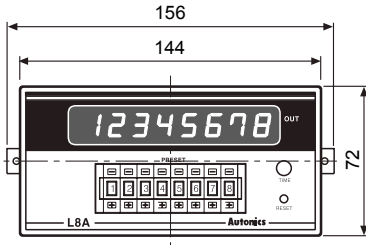

### Panel cut-out

(unit: mm)

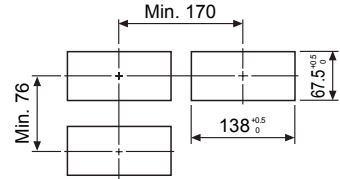

## Connections

### F8A

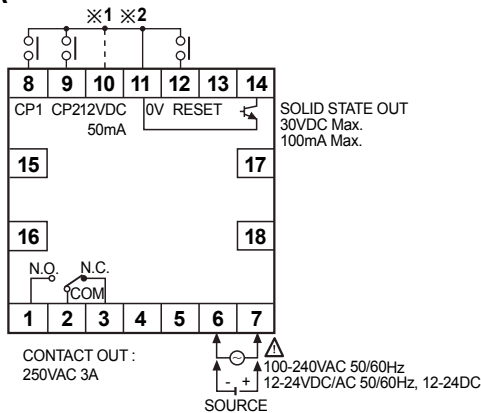

### F8B

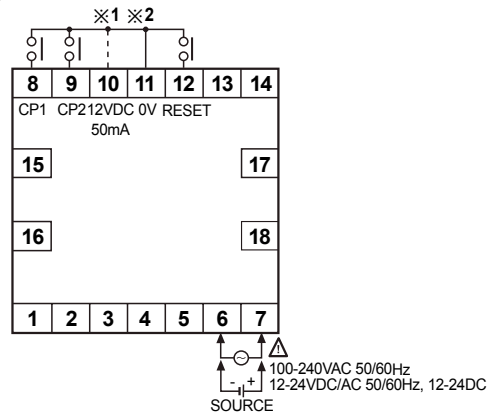

### L8A

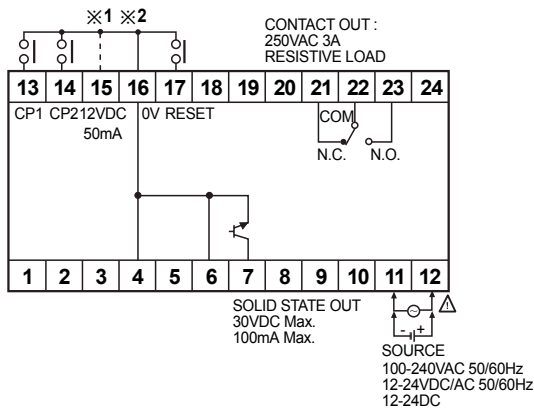

### L8B

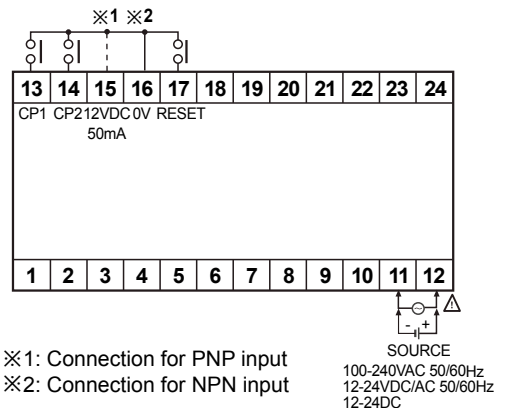

※1: Connection for PNP input  
 ※2: Connection for NPN input

(A)	Photo electric sensor
(B)	Fiber optic sensor
(C)	Door/Area sensor
(D)	Proximity sensor
(E)	Pressure sensor
(F)	Rotary encoder
(G)	Connector/Socket
(H)	Temp. controller
(I)	SSR/ Power controller
(J)	Counter
(K)	Timer
(L)	Panel meter
(M)	Tacho/ Speed/ Pulse meter
(N)	Display unit
(O)	Sensor controller
(P)	Switching mode power supply
(Q)	Stepper motor& Driver&Controller
(R)	Graphic/ Logic panel
(S)	Field network device
(T)	Software
(U)	Other

# F/L Series

## Input logic selection

### F Series

Input logic is changeable by input logic selection switch located at the one-side of case.

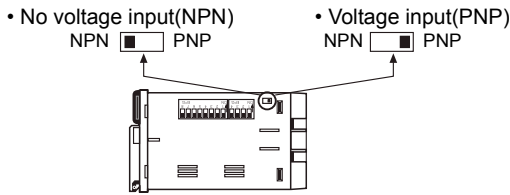

### L Series

Input logic is changeable by input logic selection switch located at the terminal block.

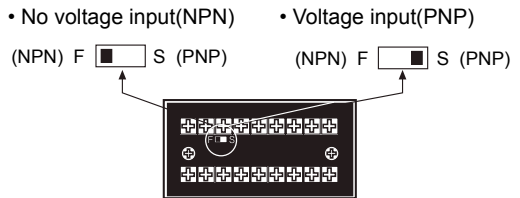

※Please be sure to turn OFF the power before changing input logic.

## Input connections

### ○ No voltage input(NPN)

#### • Solid-state input(Standard sensor : NPN output type sensor)

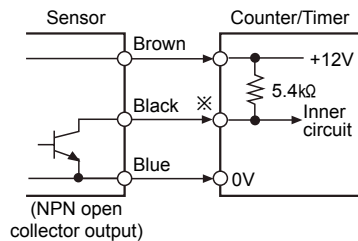
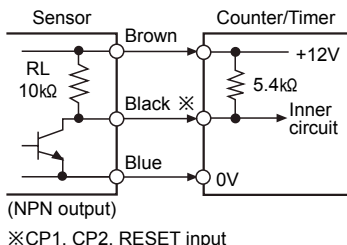

#### • Contact input

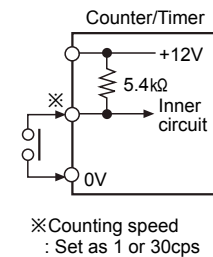

### ○ Voltage input(PNP)

#### • Solid-state input(Standard sensor : PNP output type sensor)

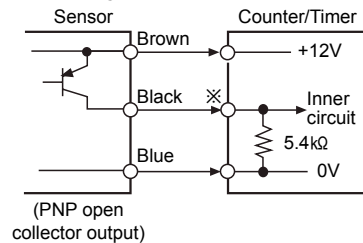
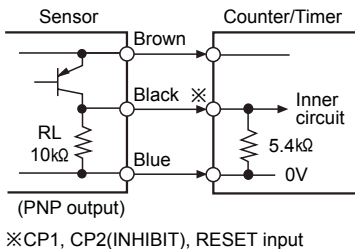

#### • Contact input

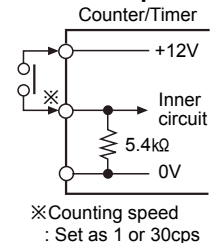

## Input & output connections

### ○ In case of operating the load by power supply of the sensor

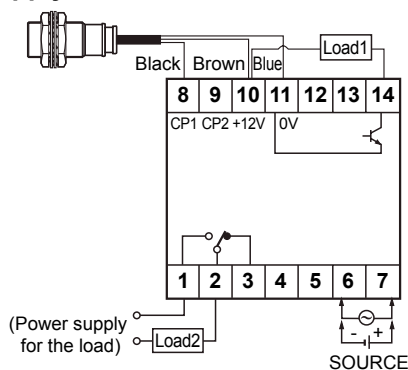

- Please select proper capacity of load, because total value of load capacity and current consumption should not be exceed current capacity(Max. 50mA).

### ○ In case of operating the load by external power supply

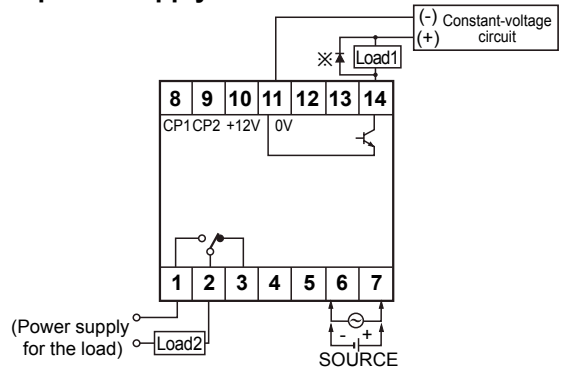

- The capacity of the load must not be exceed Max. 30VDC, Max. 100mA of the switching capacity of the transistor.
- Please do not supply the reverse polarity voltage.  
※In case of using the inductive load(Relay, etc.), please connector the surge absorber(Diode)at both terminals of the load, in case of using the inductive load.

# 8 digit Up/Down/Up-Down Counter

## ■ Description of inner DIP switches

### ● F Series

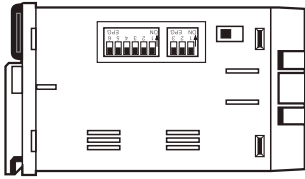

### ● L Series

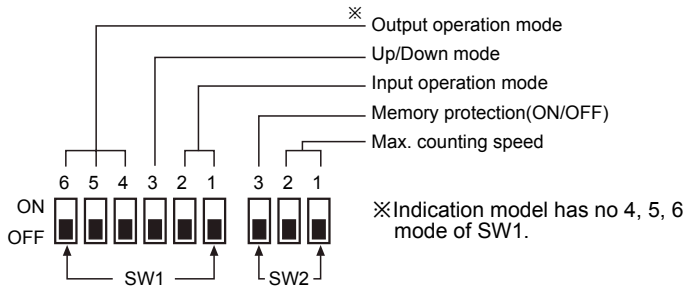
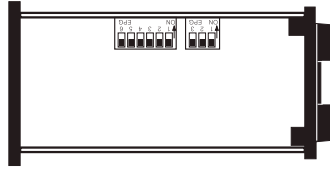

### ● Memory protection

SW2	Function
ON 3 OFF <input type="checkbox"/>	Disable the memory protection
ON 3 OFF <input type="checkbox"/>	Enable the memory protection

### ● Selecting max. counting speed

SW2	Function
ON 1 2 OFF <input type="checkbox"/> <input type="checkbox"/>	1cps
ON 1 2 OFF <input type="checkbox"/> <input type="checkbox"/>	30cps
ON 1 2 OFF <input type="checkbox"/> <input type="checkbox"/>	2kcps
ON 1 2 OFF <input type="checkbox"/> <input type="checkbox"/>	5kcps

## ■ Counting operation of indication type

### ● Up mode

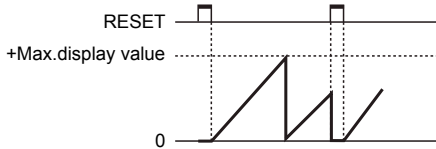

### ● Down mode

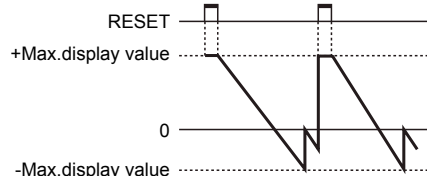

### ● Up / Down-A, B, C input mode

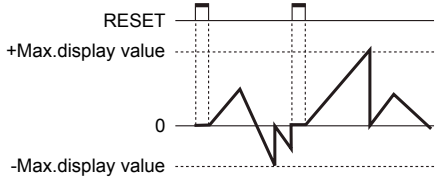

### ● Up / Down-D, E, F mode

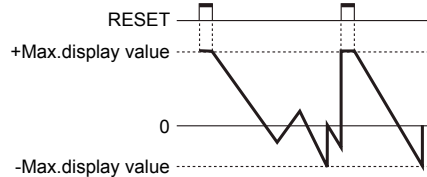

## ■ Setting function of Decimal point

Display the decimal point.

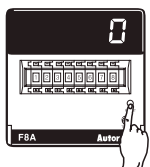

RUN mode

※ Press RESET button for over 3sec., it advances to decimal point setting mode.

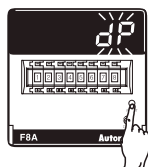

※ When "dP" is flashing, one touch the Reset button.

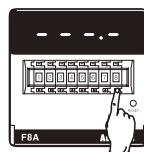

※ Set the position of decimal point using (+, -) button of digital switch.

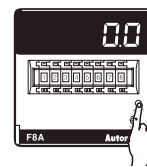

Return to RUN mode

※ Press RESET button for over 3sec., it returns to RUN mode.

### ● Changing the decimal point

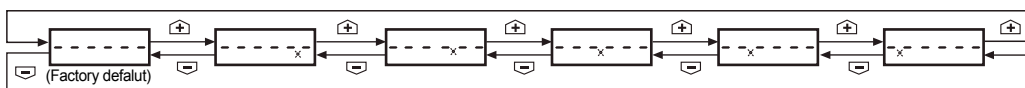

※ It returns to RUN mode if no RESET button or digital switch is applied for 60sec. in decimal point setting status.

※ The decimal point setting is existed in indication type.

(A) Photo electric sensor

(B) Fiber optic sensor

(C) Door/Area sensor

(D) Proximity sensor

(E) Pressure sensor

(F) Rotary encoder

(G) Connector/Socket

(H) Temp. controller

(I) SSR/Power controller

(J) Counter

(K) Timer

(L) Panel meter

(M) Tacho/Speed/Pulse meter

(N) Display unit

(O) Sensor controller

(P) Switching mode power supply

(Q) Stepper motor& Driver&Controller

(R) Graphic/Logic panel

(S) Field network device

(T) Software

(U) Other

## Input operation mode(Counter)

Input mode(SW1)		SW1	No-voltage input type(NPN)	Voltage input type(PNP)
Up mode	Up/Down-A (Command input)	ON <input type="checkbox"/> 3 OFF <input checked="" type="checkbox"/>		
	Up/Down-B (Individual input)	ON <input checked="" type="checkbox"/> 1 OFF <input checked="" type="checkbox"/> 2		
	Up/Down-C (Phase difference input)	ON <input checked="" type="checkbox"/> 1 OFF <input checked="" type="checkbox"/> 2		
	Up (Count up input)	ON <input checked="" type="checkbox"/> 1 OFF <input checked="" type="checkbox"/> 2		
Down mode	Up/Down-D (Command input)	ON <input checked="" type="checkbox"/> 3 OFF <input type="checkbox"/>		
	Up/Down-E (Individual input)	ON <input checked="" type="checkbox"/> 1 OFF <input checked="" type="checkbox"/> 2		
	Up/Down-F (Phase difference input)	ON <input checked="" type="checkbox"/> 1 OFF <input checked="" type="checkbox"/> 2		
	Down (Count down input)	ON <input checked="" type="checkbox"/> 1 OFF <input checked="" type="checkbox"/> 2		

※Ⓐ: Over min. signal width, ⓐ: Over 1/2 of min. signal width.  
If the signal width of Ⓐ or ⓐ is less than min. signal width, ±1 of count error occurs.

# 8 digit Up/Down/Up-Down Counter

## Output operation mode

		← One-shot output(0.05 to 5sec.) <span style="margin-left: 200px;"> ← Retained output</span>			
Output mode (SW1)	ON <b>Up mode</b> OFF		ON <b>Down mode</b> OFF		Operation after count up
	UP, UP / Down-A, B, C		Down, UP / Down-D, E, F		
<b>F</b>	ON OFF			The display value continues until reset signal is applied and the output will be held. • Retained output will be maintained until Reset signal is applied.	
<b>N</b>	ON OFF			Display value and retained output are maintained until Reset signal is applied.	
<b>C</b>	ON OFF			The display value returns to reset start status when display value is reached to setting value.	
<b>R</b>	ON OFF			The display value is held until output is OFF then returns to reset start status.	
<b>K</b>	ON OFF			The display value continues until reset signal is applied.	
<b>P</b>	ON OFF			The display value is held during one-shot output time, counting process is returned to reset start status when output is ON.	
<b>Q</b>	ON OFF			The display value continues during one-shot output time.	
<b>S</b>		<b>Up input</b>	<b>Down input</b>	• Up, UP/Down-A, B, C input mode - Output is ON when (Display value) ≥ (Setting value) • Down, UP/Down-D, E, F input mode - Output is ON when (Display value) ≤ (Zero)	
ON OFF					

※One-shot output time is set by front TIME adjuster.

- (A) Photo electric sensor
- (B) Fiber optic sensor
- (C) Door/Area sensor
- (D) Proximity sensor
- (E) Pressure sensor
- (F) Rotary encoder
- (G) Connector/Socket
- (H) Temp. controller
- (I) SSR/ Power controller
- (J) Counter
- (K) Timer
- (L) Panel meter
- (M) Tacho/ Speed/ Pulse meter
- (N) Display unit
- (O) Sensor controller
- (P) Switching mode power supply
- (Q) Stepper motor& Driver&Controller
- (R) Graphic/ Logic panel
- (S) Field network device
- (T) Software
- (U) Other

# F/L Series

## ■ Proper usage

### ○ Reset function

#### ● Reset

In case of changing the input mode after supplying the power, please take an external reset or manual reset. **If reset is not executed, the counter will be working as previous mode.**

#### ● Reset signal width

It is reset perfectly when the reset signal is applied during **min. 20ms** regardless of the contact input & solid-state input.

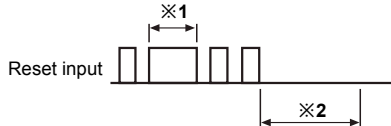

※1: In case of a contact reset, it is reset perfectly if the ON time of reset signal is applied during min. 20ms even though a chattering is occurred.

※2: It can be input the signal of CP1 & CP2 after min. 50ms from closing time of reset signal.

### ○ Min. signal width of CP1, CP2 input

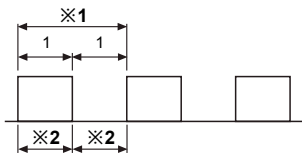

※1: Please make duty ratio(ON/OFF) as 1:1.

※2: Min. signal width

- 1cps : Min. 500ms
- 30cps : Min. 16.7ms
- 2kcps : Min. 0.25ms
- 5kcps : Min. 0.1ms

### ○ Max. counting speed

This is a response speed per 1 sec. when the duty ratio (ON:OFF) of input signal is 1:1. If the duty ratio is not 1:1, the width between ON and OFF should be over min. signal width and the response speed is getting slower against input signal. If either ON or OFF signal is shorter than minimum signal width, this product may not respond.

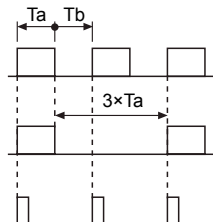

Therefore Ta(ON width) and Tb(OFF width) needed to be over min. signal width.

Max. counting speed is 1/2 value of rated spec. when duty ratio is 1:3.

It can not respond if it is smaller than min. signal width(Ta).

### ○ Error display

Error signal	Error description	Returning method
Err 0	Zero setting status	Change the setting value to non zero status

※When Error is displayed, the output continues OFF state.

※There is no Error function in indicator.

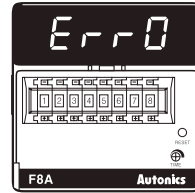

### ○ Power

The inner circuit voltage starts to rise up for the first 100ms after power on, the input may not work at this time. And also the inner circuit voltage drops down for the last 500ms after power off, the input may not work at this time.

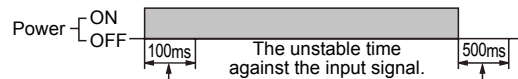

## ■ Case & DIP switch detachment

### ● F Series

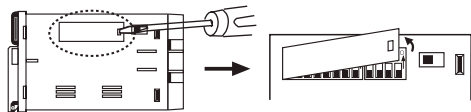

Push a lock part to front direction and widen it simultaneously.

※Please be careful to use with tools, it may cause injury.

### ● L Series

Please turn off the power before detaching the case.

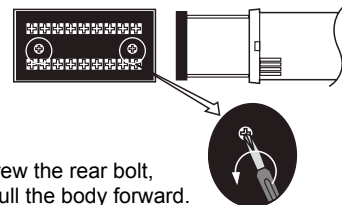

Unscrew the rear bolt, and pull the body forward.

※Please be careful of the injury caused by tools.